

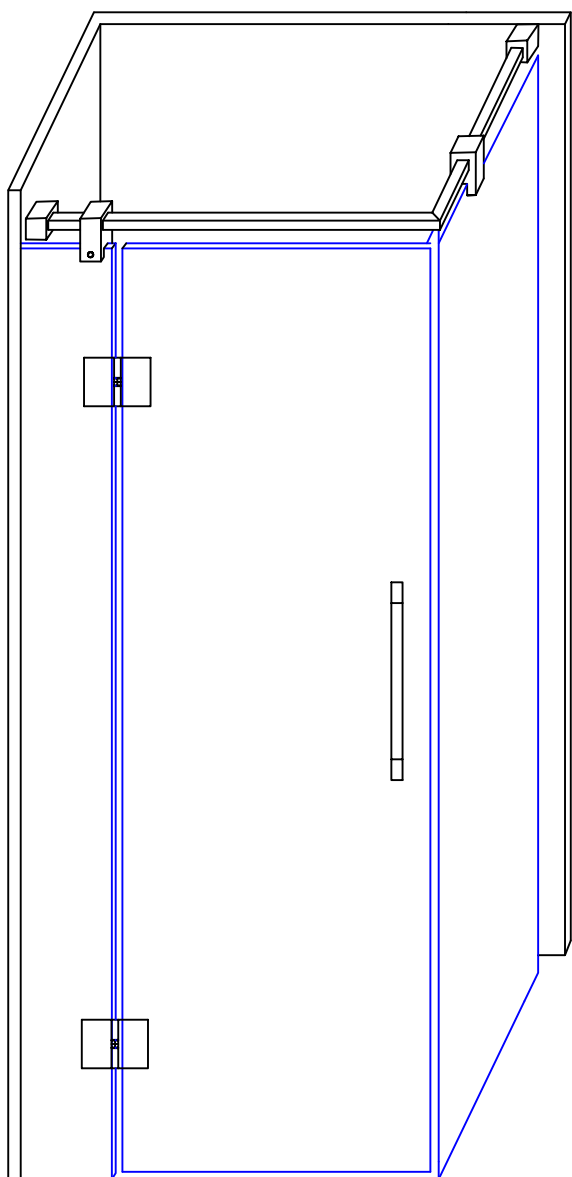

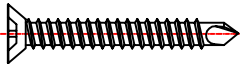







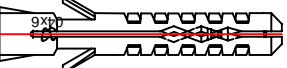



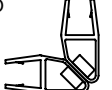

Navodilo za montažo - DIONA

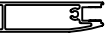

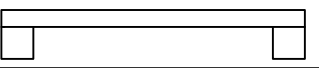
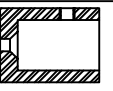
DIONA sestavni deli

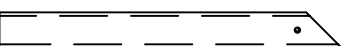
DEL	KOS	ŠIFRA
VIJAK 4,8×45 	2	A
VIJAK 3,9×38 	8	B
PVC VLOŽEK 	10	C
VIJAK M6×6 	4	D
VIJAK M4×6 	2	E
PVC NAVOJNI ZATIČ M8×10 	2	F
VIJAK 3,5×9,5 	8	G
MAGNETNO TESNILO +45° -45° 	1	H
PVC TESNILO GO-04 	1	I
PVC TESNILO GO-02 	1	J
STENSKI PROFIL 	2	K
PROFIL NA STEKLU 	2	L
DVIŽNI TEČAJ STEKLO- STEKLO 	2	M
ROČAJ DIONA 	2	N
DEL 1 	2	O
DEL 2 	2	P
OJAČITVENA CEV 20×20×2 	2	R
RF VLOŽEK 	1	S

Navodilo za montažo - DIONA

1.

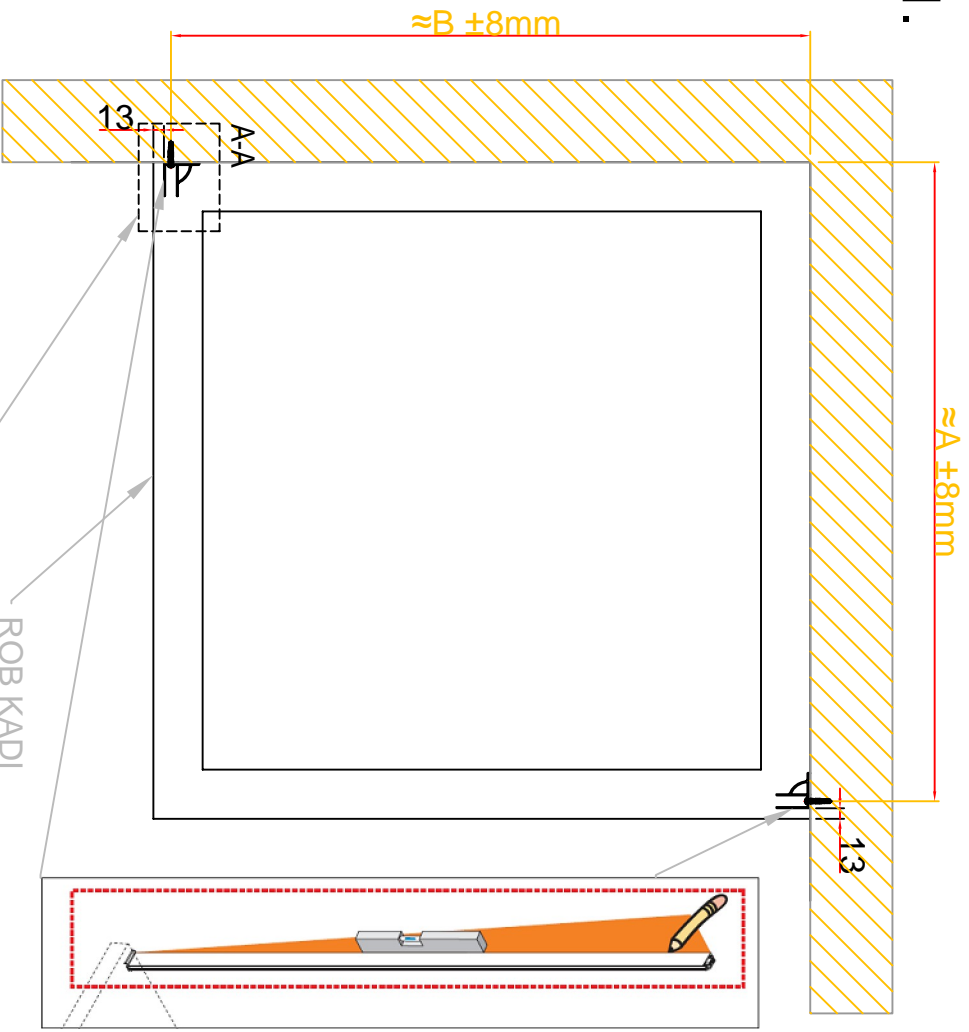

POGLEED: A-A

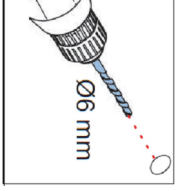

ROB KADI

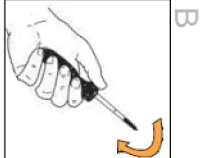

B

13

2.

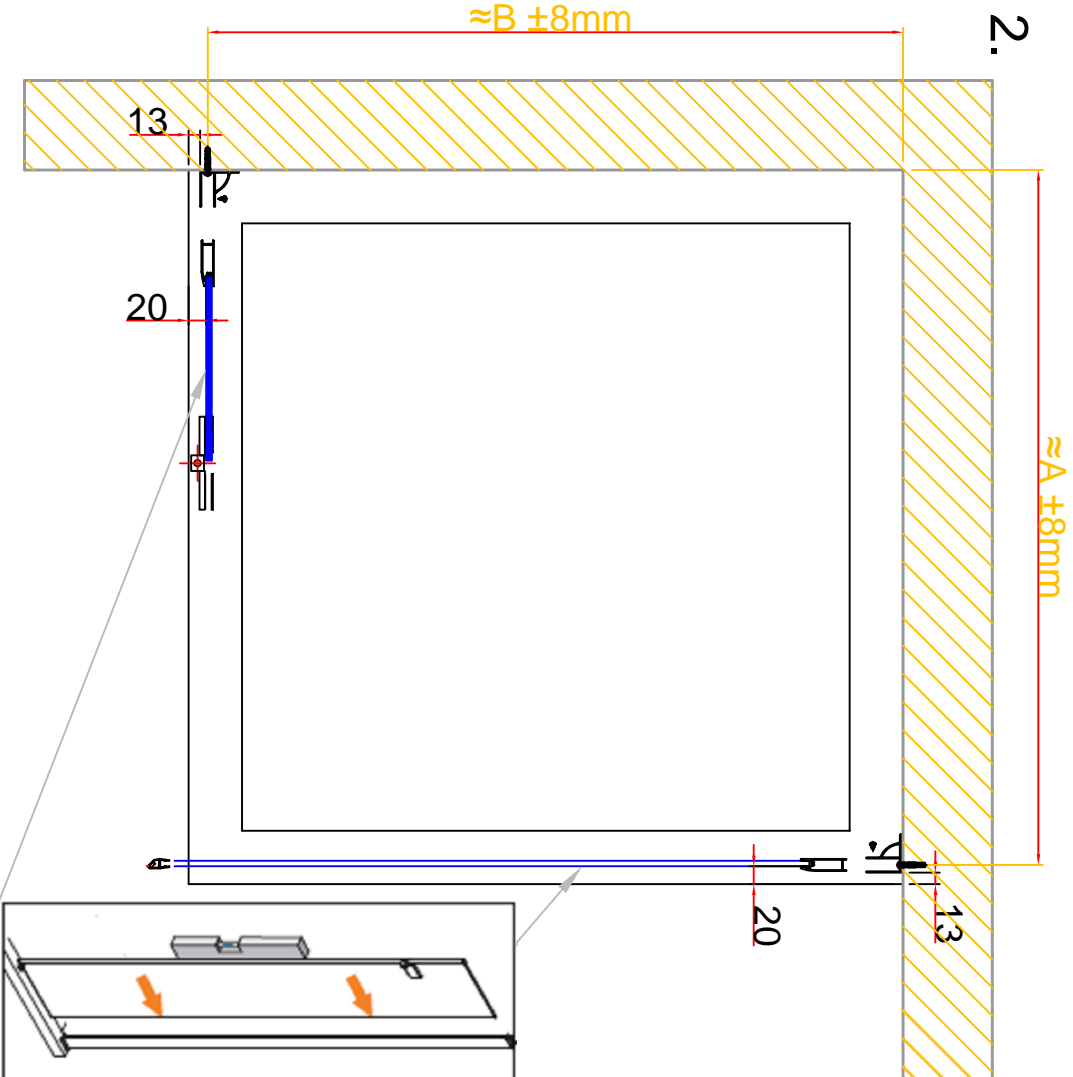

2.
G

1.

20

20

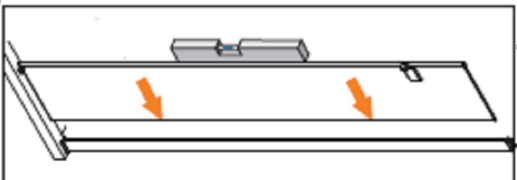

Navodilo za montažo - DIONA

3.

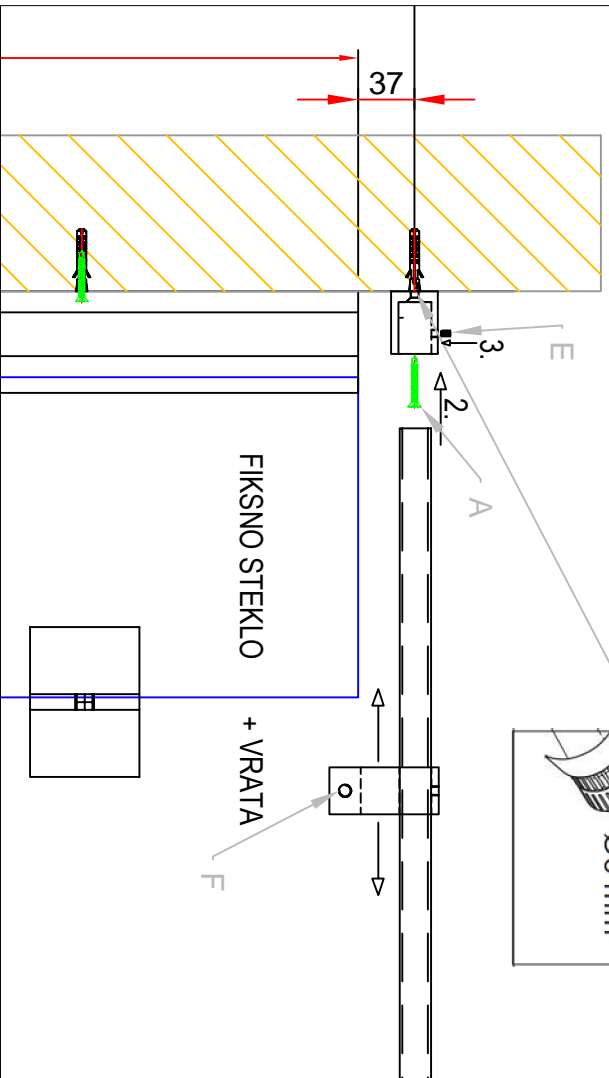

5.

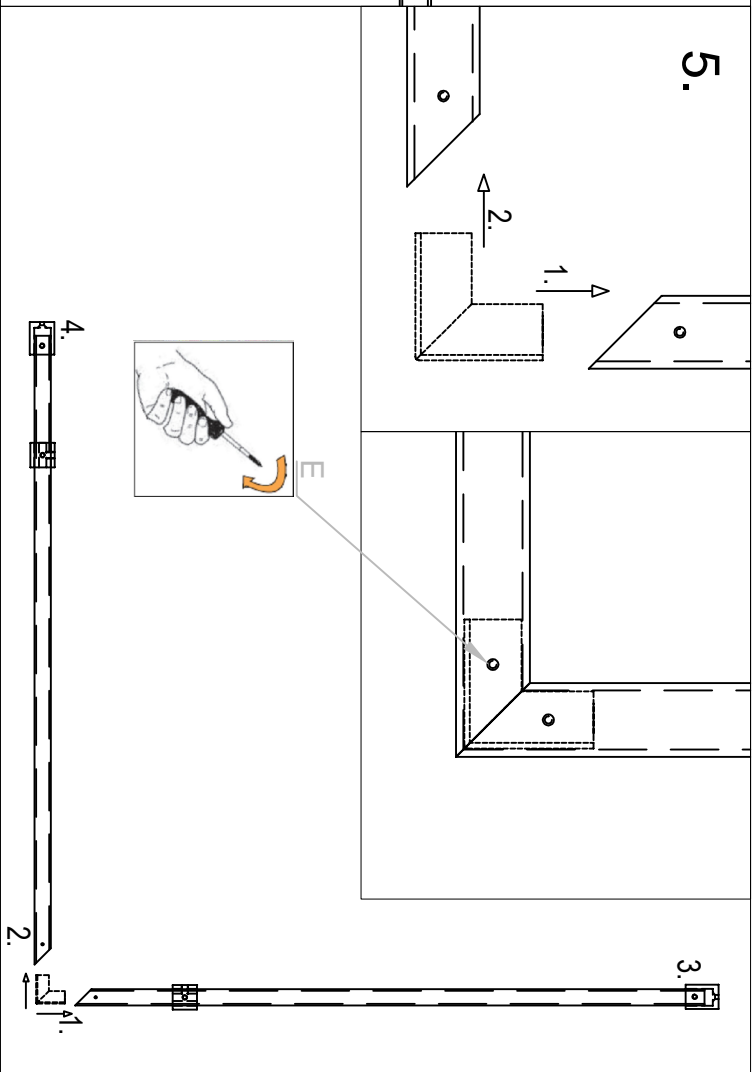

4.

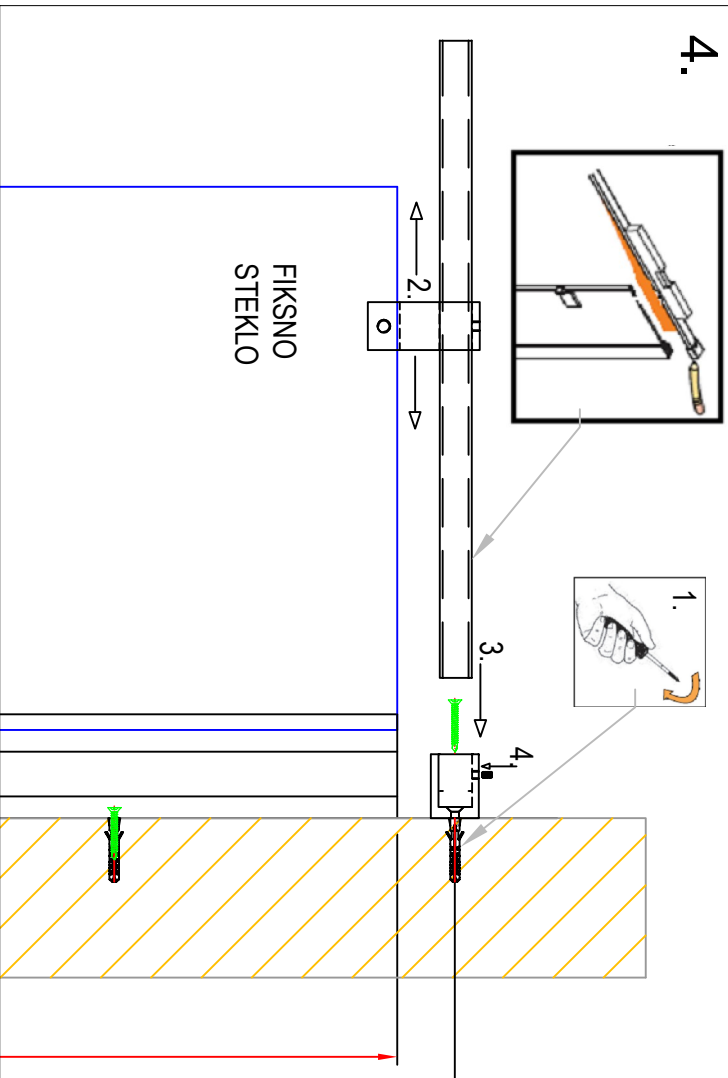

6.

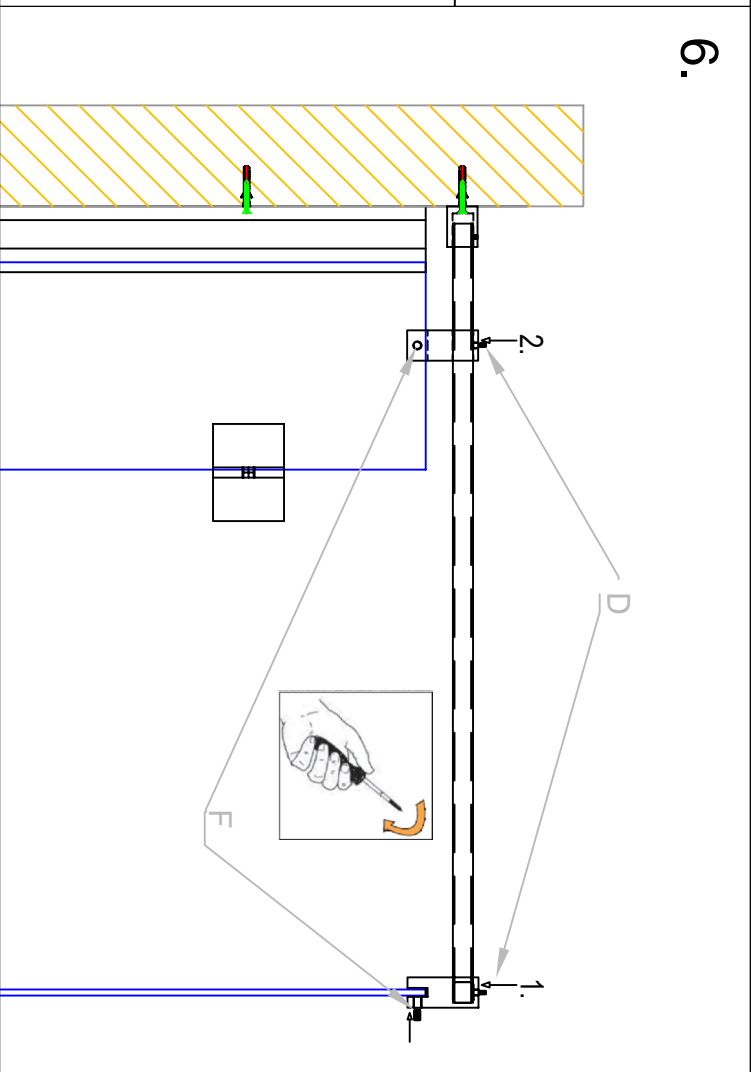

Navodilo za montažo - DIONA

7.

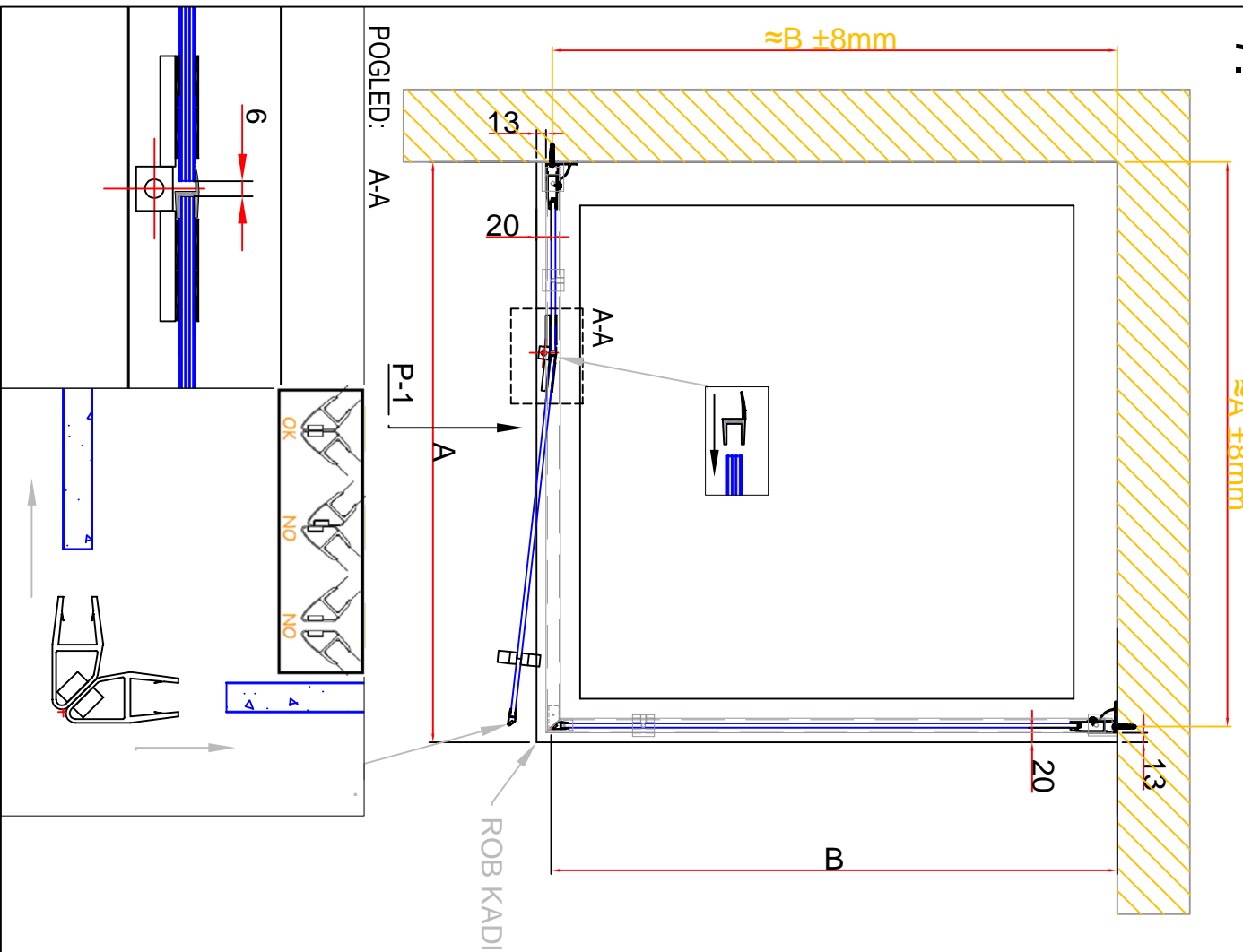

8.

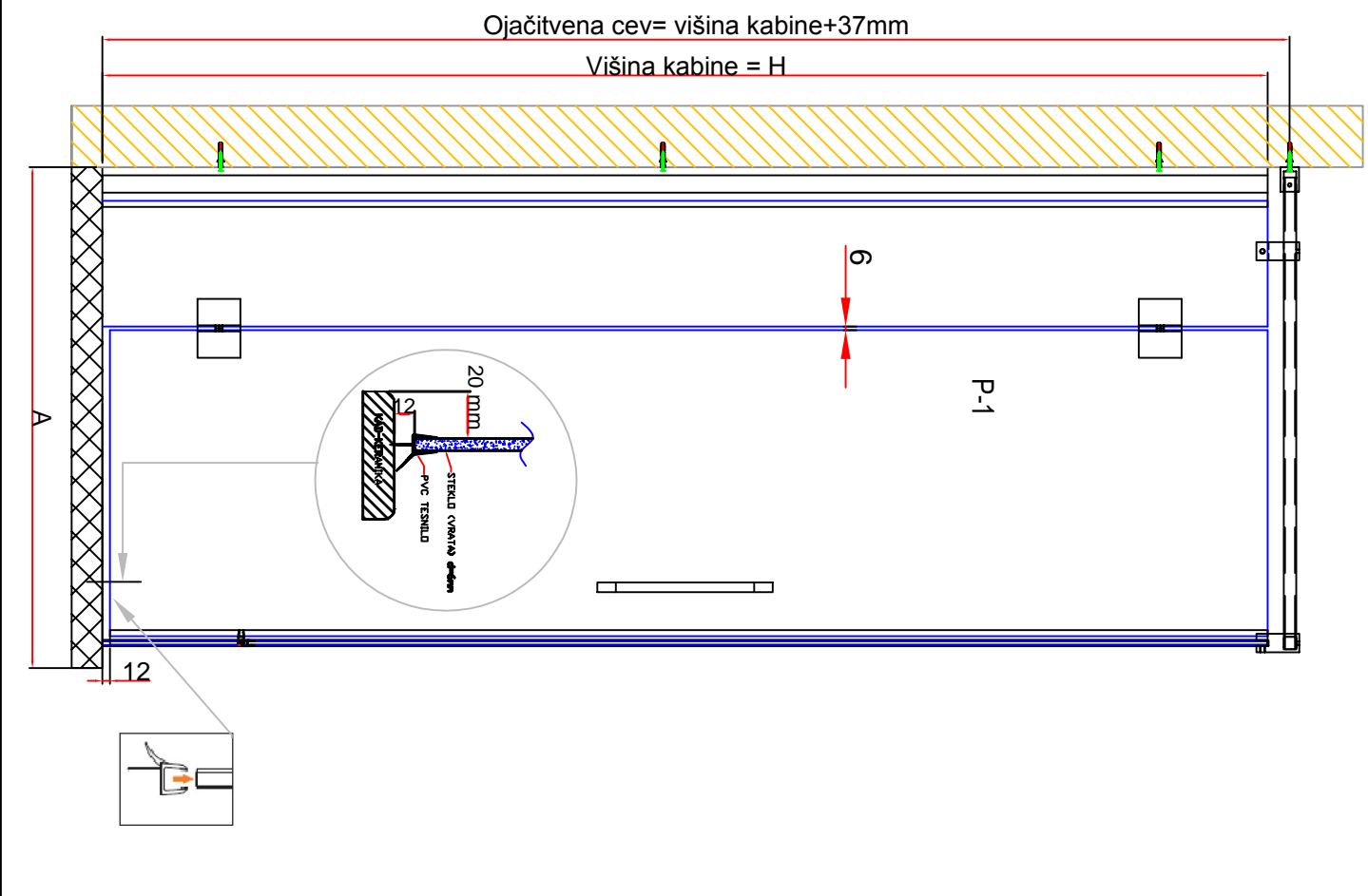

Navodilo za montažo - DIONA

9.

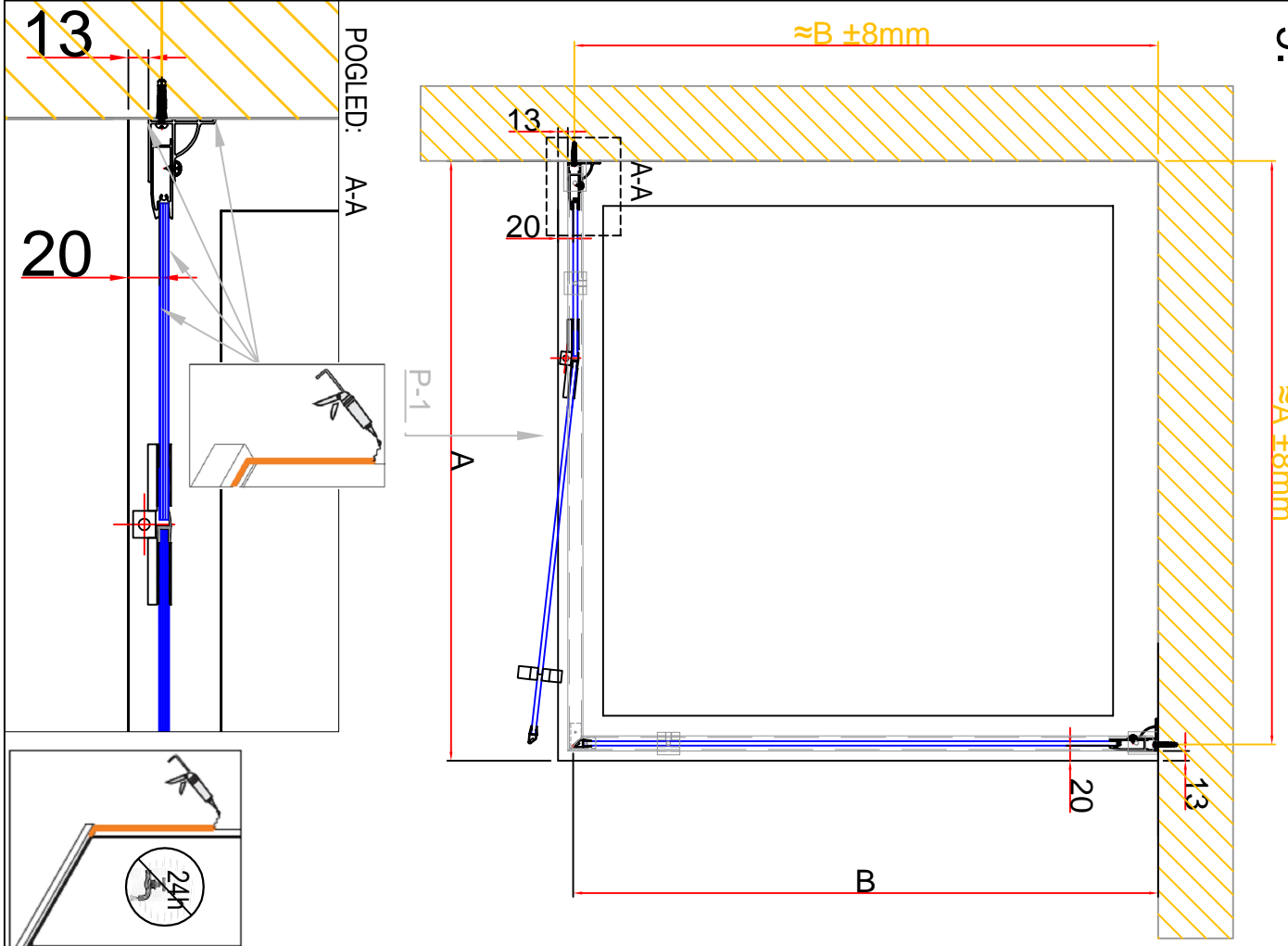

10.

